

Article number: 4320000551

Description: Rota-fix shaft-hub connection A 55x85
Stainless Steel

Measures

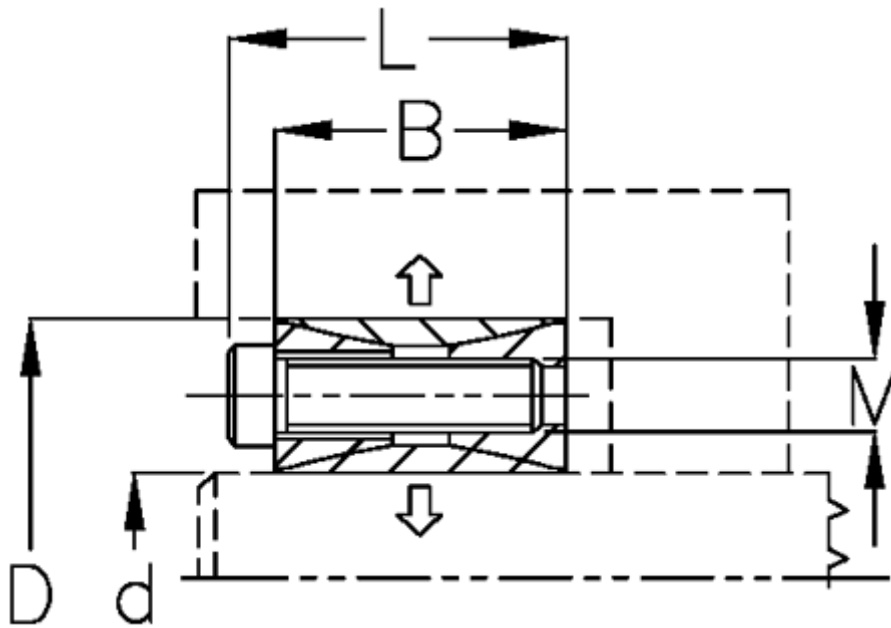

B mm	= 24
d H8 mm	= 55
D mm	= 85
Fit tolerance	= Aksel k11-h11, Nav N11-H11
F kN torque	= 51.6
L mm	= 32
M mm	= M8
P N/mm ² surface pressure on shaft/hub	= 48

Surface roughness	=
T N m torque	=
Ts N m bolt tightening torque	=